

## Research of Seepage Flow Law of Tight Oil Reservoir in North Songliao Basin

SHI Xiaodong<sup>[a],[b],\*</sup>; AI Chi<sup>[a]</sup>; ZHAN Jianfei<sup>[b]</sup>; XIAO Qianhua<sup>[c]</sup>; HU Chaoyang<sup>[a]</sup>

<sup>[a]</sup>Northeast Petroleum University, Daqing, China.

<sup>[b]</sup>Exploration and Development Research Institute of Daqing Oilfield Company Ltd., Daqing, China.

<sup>[c]</sup>Chongqing University of Science & Technology, Chongqing, China.

\*Corresponding author.

Supported by Low Permeability Reservoir Development Technology Effectively (2011ZX05013-006).

Received 13 November 2015; accepted 10 December 2015  
Published online 31 December 2015

### Abstract

Tight oil resources in north Songliao basin is rich and abundant, which is the most important energy sources foundation of Stable and raising oil production in Daqing oilfield. However, it is difficult to develop such oil resources by the regular ways and has no economic benefit for the poor reservoir property and thin reservoir thickness. Using the way of horizontal well by volume fracturing can reach the high oil production, which has showed good results up till now. But now tight oil in Daqing oilfield exploration and development is still in its infancy, the pore structure and seepage flow law of tight oil reservoir in north Songliao basin is not clear, which is potential barrier for exploring tight oil reservoirs effective development mode. Tight oil reservoir single phase and two phase fluid seepage rule are researched by means of theoretical and experimental, the results of which can provides a reliable theoretical basis for tight oil reservoir developed effectively.

**Key words:** North Songliao basin; Tight oil; Seepage flow law

Shi, X. D., Ai, C., Zhan, J. F., Xiao, Q. H., & Hu, C. Y. (2015). Research of seepage flow law of tight oil reservoir in north Songliao basin. *Advances in Petroleum Exploration and Development*, 10(2), 58-63. Available from: URL: <http://www.cscanada.net/index.php/aped/article/view/7946> DOI: <http://dx.doi.org/10.3968/7946>

### INTRODUCTION

Tight oil is adsorption or free state occurrence in source rock, with source rock layer, tight sandstone or dense carbonate reservoir without a massive long distance migration of oil accumulation<sup>[1-3]</sup>. With the enhanced exploration and development of oilfield, the unconventional reservoir are playing a more and more important role in oil field production<sup>[4-5]</sup>. Tight sandstone reservoir is an important field of unconventional oil and gas of Daqing oil field and the resource base, which is about 40% of unused reserves and the average air permeability is less than  $2 \times 10^{-3} \mu\text{m}^2$ <sup>[6]</sup>.

The test areas are carried out in Daqing oil field in view of the tight reservoir development at present, which using the large volume fracturing with the “one thousand proppant sands and ten thousand fracturing fluid” fracturing scale. From the point of production effect, horizontal well early yield is higher, early stable daily average oil production for 300 days is 13.9~29.1 t/d, but the reservoir seepage law research also needs to strengthen in-depth study for the development of boundaries and policy made<sup>[7]</sup>.

### 1. TIGHT OIL RESERVOIR GEOLOGICAL CHARACTERISTICS IN NORTHERN SONGLIAO BASIN

Tight oil reservoir has four obvious signs: (a) Larger-area distribution, porosity is less than 10%, matrix compound pressure permeability is less than  $0.1 \times 10^{-3} \mu\text{m}^2$ , pore throat diameter is less than  $1 \mu\text{m}$ . (b) Wide type distribution of mature source rock with high quality, I type or II type kerogen, average TOC>1%,  $R_o$  is 0.6%~1.3%. (c) Continuous distribution of tight reservoir and source rock for close contact symbiotic relationship without obvious trap boundary and the concept of “reservoir”. (d) Crude oil is lighter and density is less than  $0.825 \text{ g/cm}^3$ .

Tight sandstone oil resources in Daqing oilfield is rich, Mainly concentrated in the Fuyang and Gaotaizi two sets of oil-bearing series, whose general characteristics are that reserves abundance is lower, reservoir property is lower, reservoir thickness is thinner, viscosity of crude oil is higher. In addition, two sets of reservoir have their respective characteristics<sup>[9-10]</sup>.

(a) Scattered dense reservoir type represented by Fuyang oil layer. It is based on under the “source” large rivers - shallow-water delta deposition, the main kinds of the reservoir sand body include meandering river, braided river and distributary channel, and so forth. The characteristics of Fuyang tight oil reservoir are scattered longitudinal, transverse discontinuous, and severe heterogeneity. Its sand body size is 300~500 m, reserves abundance is low and most of which is  $40 \times 10^4$  t/km<sup>2</sup>, reservoir thickness is thinner, reservoir property is poorer, air permeability is  $0.1 \sim 5 \times 10^{-3}$  μm<sup>2</sup> but most of which is less than  $2 \times 10^{-3}$  μm<sup>2</sup>. The reservoir buried depth is deeper and an average of 1,900 meters. Compared with other fields at home and abroad, the reservoir almost develop no natural fracture and its fracture linear density is less than 0.1 cracks/meter<sup>[11-14]</sup>.

(b) Stable dense oil reservoir type represented by Gaotaizi oil layer. It is based on “Source” delta and outside front-delta deposition. The sand bodies were widely deposited and the thickness is 5~10 m, porosity is commonly 8%~12%, air permeability is less than  $1 \times 10^{-3}$  μm<sup>2</sup>, so seepage capability is poorer. The reservoir and good hydrocarbon source rock Mutual developed, hydrocarbon generation and reservoir were associated, which is favorable horizon of tight sandstone reservoir exploration.

## 2. RESEARCH OF SINGLE-PHASE FLUID SEEPAGE LAW IN TIGHT OIL RESERVOIR

### 2.1 Non-Linear Seepage Experiment

The advanced micro flow test equipments are adopted for nonlinear experiment system, the pressure gradient at the ends of the core is dropped gradually till the value of the minimum, which guarantee the accuracy of the test.

#### 2.1.1 Experiment Equipments

The experiment equipments include: nitrogen gas bottle, middle container, pressure sensor, photoelectric decay tube flow meter (inside diameter of 1.38 mm, length is 150 mm, Surface flow displacement precision can reach micron grade), core holding unit, manual pump (provide core with confining pressure).

#### 2.1.2 The Experimental Steps and Process

(a) The cores of experiment are washed oil and dried. Then the cores are highly evacuated and fully saturated by simulated formation water.

(b) The cores are put into core holding unit and added confining pressure. When the displacement pressure is higher, the pressure on both ends of core holding unit should be controlled by regulating the cylinder flow, then seepage experiment is made according to the experiment scheme, the fluid surface displacement and the time required under different pressures in micro-flow meter should be recorded, in this way flow velocity can be calculated. When the displacement pressure is lower, low pressure source can be offered by using the constant pressure water head.

(c) The seepage curves are plotted according to the measured pressure and flow rate. Figure 1 is schematic diagram of experimental set-up .

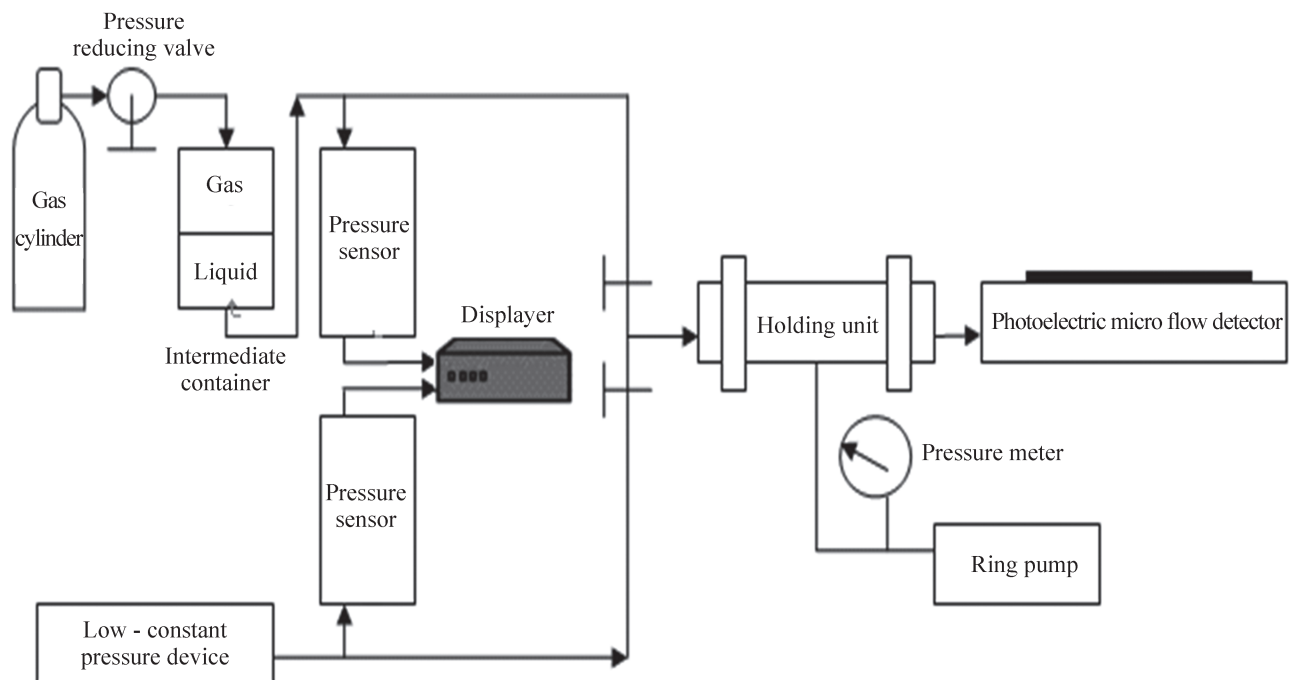

**Figure 1**  
**Non-Linear Seepage Test Device**

### 2.2 Reach of the Start-up Pressure Gradient

Non-linear seepage law of single-phase water is researched by ten tight sandstone cores of Fuyang and Gaotaizi two sets of oil-bearing series in Daqing oilfield, permeability of the cores distribution in between  $0.046\sim 0.529\times 10^{-3}\mu\text{m}^2$ . Test results are showed as Table 1.

**Table 1**  
Non-Linear Test Results of Tight Oil Reservoir in Daqing Oilfield

Core number	Well number	Layer	permeability ( $10^{-3}\mu\text{m}^2$ )	Real start-up pressure gradient (MPa/m)	Threshold start-up pressure gradient (MPa/m)
2 II	Zhou201	F	0.055	0.386	1.661
5 II	Pu463	F	0.169	0.076	0.540
6 II	Pu463	F	0.181	0.133	0.452
15	Zhou16	F	0.182	0.099	0.239
1 II	Pu482	F	0.384	0.060	0.180
30	Jin28-Z3	G	0.046	0.321	0.729
37	Jin28-Z3	G	0.098	0.066	0.351
23	Long26-Z2	G	0.113	0.062	0.429
37 II	Jin191	G	0.235	0.042	0.231
21	Ta234	G	0.529	0.048	0.161

Permeability and start-up pressure gradient correlation curves can be plotted according to the history nonlinear experimental data of the two oil layers, which are showed as Figures 2~5.

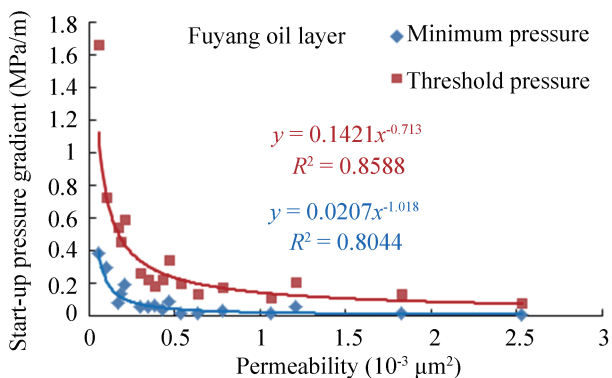

**Figure 2**  
Relationship Between Pressure Gradient and Permeability of Fuyang Oil layer

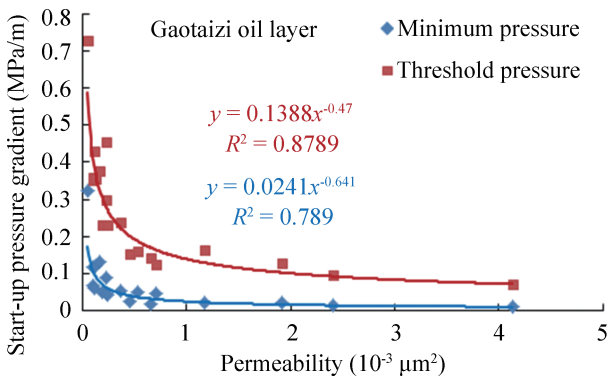

**Figure 3**  
Relationship Between Pressure Gradient and Permeability of Gaotaizi Oil layer

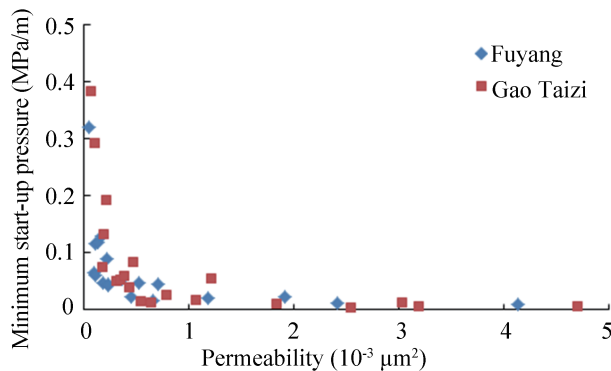

**Figure 4**  
Minimum Pressure Gradient Contrast in Different Reservoirs

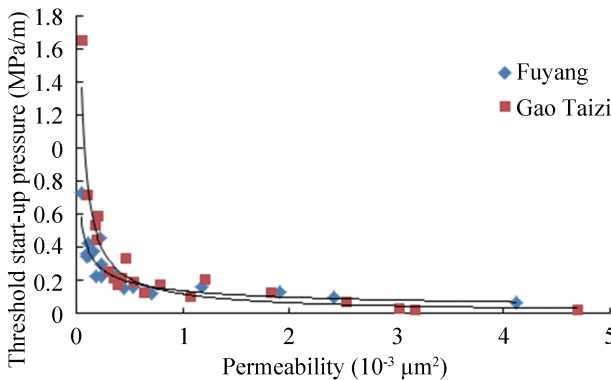

**Figure 5**  
Threshold Pressure Gradient Contrast in Different Reservoirs

As can be seen from the table and chart, with the increase of permeability, minimum start-up pressure gradient and threshold start-up pressure gradient decreases, which presented good power function relationship compared with permeability. However, with the increase of permeability, the start-up pressure gradient of two oil layer are not obvious.

### 2.3 Applications of the Experimental Data

Non-linear seepage experiment data has been widely used in the oil and gas development, fluid flow in the limit of the distance can be calculated by limit spacing method, the effective use of coefficient method and numerical simulation method. The effective use of coefficient method and numerical simulation method are accurate calculations but need a large amount of data. Therefore, fluid flow in the limit of the distance is calculated by simplifying by limit spacing method in this text, the advantage of which method is fast, simple, and need less basic parameters. The theoretical basis of the specific as follows:

It is indicated by source-sink collect steady radial flow seepage theory of constant-production that the mainstream of seepage velocity is biggest of all the filament line. In the same filament line, the seepage velocity on source of equidistance is minimum.

When it is a steady flow,  $Q = v \cdot A$ , which is a constant. The seepage velocity can be expressed as:

$$v = \frac{Q}{A} = \frac{Q}{2\pi rh} \quad (1)$$

Plane radial flow formula for production can be expressed as:

$$Q = \frac{2\pi Kh [p_e - p_w - \lambda(R_e - r_w)]}{\mu \ln \frac{R_e}{r_w}} \quad (2)$$

Where  $\lambda$  is start-up pressure gradient. By seepage velocity Equation (1) put into production Equation (2), flow velocity formula can be defined as:

$$v = \frac{k [p_e - p_w - \lambda(R_e - r_w)]}{\mu \ln \frac{R_e}{r_w}} \frac{1}{r} \quad (3)$$

The pressure gradient of any formation can be defined as according the flow velocity equation:

$$\frac{dp}{dr} - \lambda = \frac{p_e - p_w - \lambda(R_e - r_w)}{\ln \frac{R_e}{r_w}} \frac{1}{r} \quad (4)$$

Therefore, the pressure gradient of midpoint in constant-production source-sink flow seepage can be defined as:

$$\frac{dp}{dr} = \lambda + \frac{P_H - P_w - \lambda(R - r_w)}{\ln \frac{R}{r_w}} \cdot \frac{2}{R} \quad (5)$$

Where  $P_w$  is production well bottom flowing pressure,  $P_H$  is water injection well bottom flowing pressure,  $R$  is injection-production well spacing,  $r_w$  is wellbore radius.

If the oil at midpoint of the mainstream line are wanted to flow, that driving pressure gradient of the midpoint must be greater than the start-up pressure gradient, according to which, the limiting injection-production well spacing of different injection-production pressure differential under the condition of a certain permeability can be calculated as:

$$R = r_w + \frac{P_H - P_w}{\lambda} \quad (6)$$

Assuming that effective injection-production pressure difference is 15 MPa and the wellbore radius is ignored, the limit of the fluid flow is calculated with different permeability range under different condition the average start-up pressure gradient, the calculation results are showed in Table 2.

It can be seen from the above chart data: when the permeability is less than  $0.5 \times 10^{-3} \mu\text{m}^2$ , limit spacing of Fuyang reservoir is less than 28.5 m, limit spacing of Gaotaizi reservoir is less than 32.3 m, when the permeability is less than  $1.0 \times 10^{-3} \mu\text{m}^2$ , limit spacing of Fuyang reservoir is less than 52.1 m, limit spacing of Gaotaizi reservoir is less than 63.4 m. It is observed that the development of Fuyang reservoir difficulty is higher than Gaotaizi reservoir, the smaller the permeability, the

greater the difference of two reservoirs. However, when the permeability is less than  $0.1 \times 10^{-3} \mu\text{m}^2$ , limit spacing has dropped to less than 20 m, development of the two reservoirs are extremely hard. Therefore, according to this research, the tight oil reservoir of which permeability is less than  $0.1 \times 10^{-3} \mu\text{m}^2$  in Songliao basin is can't to develop at the current technology.

**Table 2**  
**Limit Well Spacing Under Different Permeability of Tight Oil Reservoir**

Oil layer	Limiting injection-production well spacing (m)				
	0.01	0.05	0.1	0.5	1.0
Permeability ( $10^{-3} \mu\text{m}^2$ )					
Fuyang	1.3	5.4	14.0	28.5	52.1
Gaotaizi	3.8	8.5	15.9	32.3	63.4

### 3. RESEARCH OF TWO-PHASE FLUID SEEPAGE LAW IN TIGHT OIL RESERVOIR

Research on the laws of the two phase flow is significant in the development of oil, which is also the basis for oilfield complement producing energy. Compared with middle and high permeability reservoir, tight oil reservoir development has the characteristics of low recovery efficiency, big flow resistance. In this paper, oil-water flow and distribution rule in the tight oil reservoir is studied on the basis of laboratory experiments.

#### 3.1 Test Method of Relative Permeability

The tight oil core relative permeability curve is measured by using unsteady method measuring, and the process, and experimental process according to *The Law of the People's Republic of China on Oil and Gas Industry Standard-The Oil-Water Relative Permeability Measurement Method (Unsteady Seepage)* (SY5345-2007).

Experiment steps of measure the relative permeability curves of the tight oil cores are as follows:

- (a) Measuring core gas permeability, core size, dry weight and other basic data.
- (b) Saturate the core by formation water, measure core wet weight, calculate core porosity.
- (c) Installation process according to the experiment flow chart as shown in Chart 6.
- (d) Put crude oil into a intermediate container, make the core fixed in holding unit and add ring pressure.
- (e) Open the calorstat, temperature should be stabilized in the experimental temperature required.
- (f) The core is displaced by crude oil until there is no water extraction and water yield in the core is measured. The original oil saturation and irreducible water saturation are calculated.
- (g) Pressure and flow of the different time are measured in the water flooding process.

Quizix pump experiment system is used in these experiments, pressure measurement is done by 0.15% pressure sensor, the pressure is recorded directly by a computer. Specific experimental process is as below:

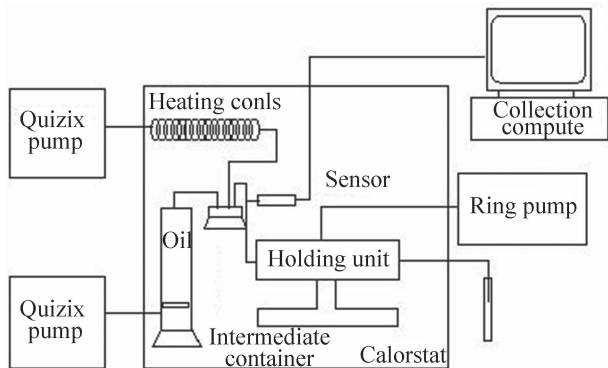

**Chart 6**  
The Experimental Flow Graph of Relative Permeability Curve Test

**3.2 Test Results Analysis of Relative Permeability**

According to the research needs, ten pieces tight oil rocks are selected for oil- water two phase percolation law research, test results such as Table 3.

Fuyang oil layer: Irreducible water saturation is between 36.5% to 53.8%, and 44.5% on average, residual oil saturation is between 32.1% to 36.8%, and 34.8% on average, two phase seepage area is 20.7% on average. The oil ultimate recovery is very low (35.7% on average), which reflected the characteristics of tight oil development.

Gaotaizi oil layer: Irreducible water saturation is between 33.9% to 51.8%, and 42.8% on average, residual oil saturation is between 25.5% to 45.1%, and 32.8% on average, two phase seepage area is 24.3% on average. The oil ultimate recovery is also very low (38.9% on average), which is relatively higher than of Fuyang oil layer. Analysis of the reason is that the microfracture exists to liquidity enhancement in Gaotaizi oil layer.

**Table 3**  
Relative Permeability Test Results

Number	Layer	Permeability (10 <sup>-3</sup> μm <sup>2</sup> )	Porosity (%)	Irreducible water saturation (%)	Residual oil saturation (%)	Two phase seepage zone(%)	Ultimate recovery (%)
3	F	0.226	11.070	39.600	36.800	23.600	35.190
9-2	F	0.288	11.872	48.559	36.637	14.804	28.779
9-1	F	0.339	13.196	36.499	35.034	28.467	44.829
1 II	F	0.384	15.086	44.164	32.125	23.711	42.465
2	F	0.740	11.779	53.820	33.505	12.675	27.447
23	G	0.113	9.915	40.843	45.056	14.101	23.837
34-1	G	0.256	10.752	33.900	25.500	40.600	55.260
22	G	0.849	14.820	36.900	28.600	34.500	49.230
17	G	1.533	15.474	51.767	29.879	18.354	38.053
19	G	1.775	18.072	51.054	35.019	13.928	28.455

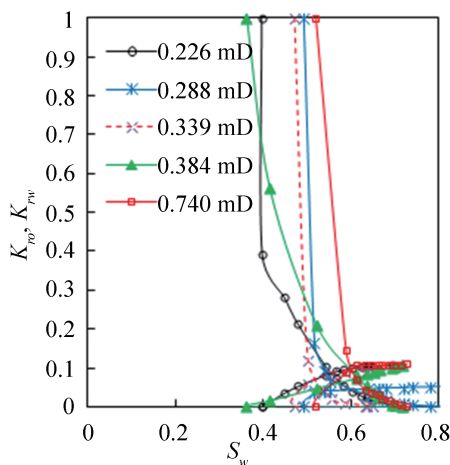

**Chart 7**  
Relative Permeability Curve of Tight Oil Core Sample in Fuyang Reservoir

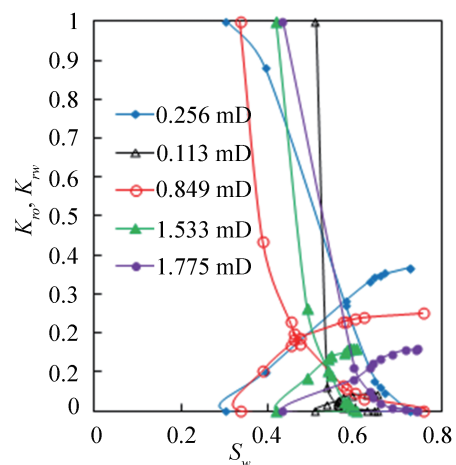

**Chart 8**  
Relative Permeability Curve of Tight Oil Core Sample in Gaotaizi Reservoir

Relative permeability curve of two types oil layer are similar, oil phase curve straight decline in the initial stage, bent slightly later, and overall decline faster.

Water phase curve of Gaotaizi reservoir is higher. Microfracture causes water phase eventual permeability is higher, Microfracture development degree of oil rocks is different, the relative permeability curve is different accordingly. There is no obvious different on water phase curve between different oil rocks of Fuyang reservoir, the larger permeability, the higher water phase curve.

---

## CONCLUSION

---

(a) With the increase of permeability, the start-up pressure gradient of two oil layer are not obvious, minimum start-up pressure gradient and threshold start-up pressure gradient decreases, which presented good power function relationship compared with permeability.

(b) Because of microfracture exist to liquidity enhancement; the ultimate recovery of Gaotaizi tight oil reservoir is relatively higher than of Fuyang tight oil reservoir.

(c) The tight oil reservoir of which permeability is less than  $0.1 \times 10^{-3} \mu\text{m}^2$  in Songliao basin is can't to develop at the current technology.

---

## REFERENCES

---

- [1] Zou, C. N., Tao, S. Z., & Hou, L. H. (2011). *Unconventional oil and gas geology*. Beijing: Geological Publishing House.
- [2] Jia, C. Z., Zou, C. N., & Li, J. Z. (2012). China tight oil evaluation standard, main types, basic characteristics and resource prospect. *Acta Petrolei Sinica*, 33(3), 343-350.
- [3] Lin, S. H., Zou, C. N., & Yuan, X. J. (2011). The dense oil development present situation and the enlightenment in USA. *Lithologic Reservoirs*, 23(4), 25-30.
- [4] Sun, Z. D., Jia, C. Z., & Li, X. F. (2011). *Unconventional oil and gas exploration and development (I)*. Beijing: Geological Publishing House.
- [5] Guo, Y. Q., & Tie, C. J. (2013). Research on characteristics of tight oil in Bakken enlightenment on tight oil exploration and development in our country. *Liaoning Chemical Industry*, 42(3), 311-312.
- [6] Xu, H. X., & Li, J. Z. (2012). Tight oil-global unconventional oil exploration and development of new hot spot. *Petroleum Exploration and Development*, 39(1), 99.
- [7] Han, D. J., Wang, Y. Z., & Zhan, J. F. (2014). Well pattern optimization technique of tight oil reservoir in Daqing oilfield. *Daqing Petroleum Geology and Development*, 33(5), 30-35.
- [8] Zou, C. N., Zhang, G. Y., & Tao, S. Z. (2010). Geological characteristics and important discoveries in the field of global oil and gas exploration and unconventional petroleum geology. *Petroleum Exploration and Development*, 37(2), 129-145.
- [9] Pang, Z. L., Zou, C. N., & Tao, S. Z. (2012). Tight oil distribution and resource potential evaluation in China. *Chinese Engineering Science*, 14(7), 60-67.
- [10] Dong, G. D., Zhang, Q., & Yan, T. (2013). Dense oil exploration and the research status. *Petroleum Geology and Engineering*, 27(5), 1-4.
- [11] Song, Y., Jiang, L., & Ma, X. Z. (2013). The formation and distribution characteristics of unconventional oil and gas reservoirs. *Journal of Palaeogeography*, 15(5), 605-614.
- [12] Liu, Z. B., Lü, Y. F., & Fu, X. F. (2009). San Zhao sag of Fuyu reservoir sedimentary characteristics and hydrocarbon accumulation pattern. *Journal of Jilin University: Earth Science*, 39(6), 998-1006.
- [13] Sun, T. W., Lü, Y. F., & Liu, Z. B. (2011). Area of daqing placanticline in Fuyu reservoir oil and gas migration and enrichment. *Petroleum Exploration and Development*, 38(6), 700-707.
- [14] Zhong, J. H., & Wang, H. Y. (2009). Fuyu reservoir characteristics research in Zhaozhou oilfield. *Special Oil & Gas Reservoirs*, 16(1), 13-15.
- [15] Zhu, X. M., Zhao, D. N., & Zeng, H. L. (2013). Terms Qingshankou formation in Songliao basin seismic sedimentology shallow-water delta sedimentary characteristics and the response. *Acta Sedimentologica Sinica*, 31(5), 889-897.